

rypen

Jeeves
Counter Table



hello@rypen.com | 800.560.0554

Jeeves Counter Table - Quick-Ship Options

Major Domo Collection



All Jeeves bases are also available in Matte Black

PRODUCT INFO

Description

Jeeves is here to take care of you. A perfect pedestal table for your cafe, breakfast nook, patio, cafeteria, restaurant and anywhere in between. **Suitable for Indoor/Outdoor use!** (see details below and on following pages) If the Quick Ship specs don't fit your project, check out our Built To Order options on the following pages or reach out!

Dimensions

Overall: H36" Dia.30"
Top: T.75" Dia.30"
Baseplate: Dia 21" / Post: Dia 3.5"

Assembly

Easy assembly with included instructions and tools. Ships flat, assembles in a few minutes!

Finishes

Matte White or Matte Black powder coated steel bases. Natural Ash, Cognac Ash, Black Ash, or Matte Black Powder Coated Steel top.

Certifications

Tested to BIFMA standards - The Jeeves table passed the 200lb load, tip-test for stability. For Built To Order tops and configurations, please reference the information on the Jeeves BTO Spec Sheets TSCA Title VI California 93120 Compliant for Formaldehyde Phase II

Construction

A 3/8" thick baseplate (with 6 nylon levelers) bolts to a 3.5" diameter post and an 1/8" thick top plate with 3/8" thick welded support braces that increase the support span for your top. All steel is powder coated for indoor/outdoor use. MDF tops are veneered with real hardwood and finished with a commercial grade matte lacquer. Steel tops are powder coated and safe for outdoor installations.

Care

Wipe clean with a soft cloth. For outdoor applications (steel or custom tops only) : see outdoor care guide at <https://www.rypen.com/help>

Lead time

In-stock ships in 2 business days. See Page 2 spec sheet for custom lead times.

Warranty

3 year Limited Warranty
For detailed information visit: <https://www.rypen.com/help/rypen-warranty>

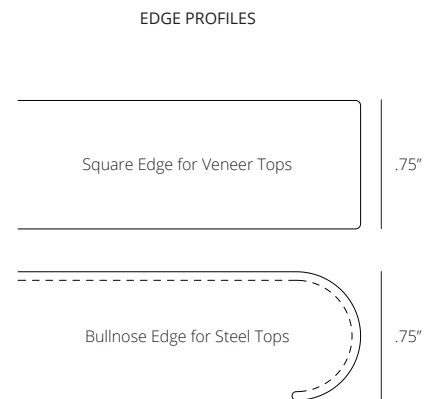
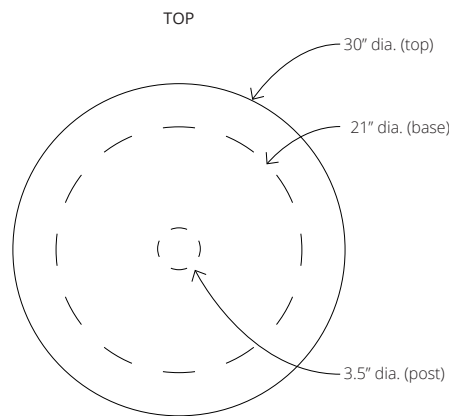
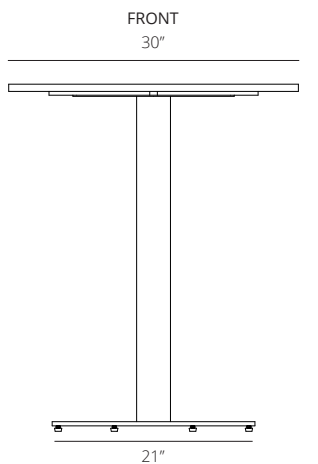

Quick Ship Bases:



Quick Ship Tops:

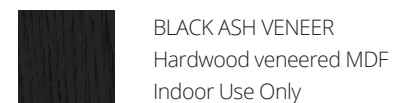
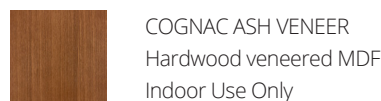
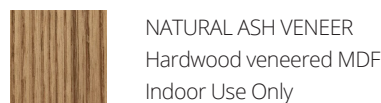

Step 1: Pick a Top

Choose the shape, size, thickness, material and edge profile.

Or supply your own top and skip to the bases.



Step 2: Pick a Post

Choose the post height and finish.

Black and White are available for quick-ship in cafe, counter and bar heights.

Step 3: Pick a Baseplate

Choose the baseplate size and finish.

Black and White are available for quick-ship in small, medium and large (depending on how big your top is and how tall your post is)

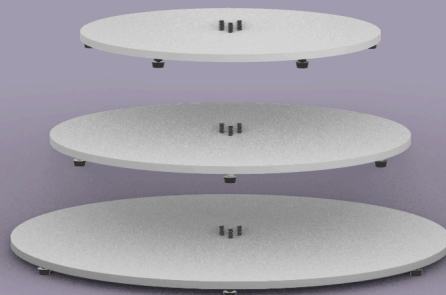

Follow the guidelines on the following pages to choose from our standardized Built To Order options or contact the Rypen Design Team to customize the Jeeves Table exactly to fit your project needs.

hello@rypen.com | 800.560.0554

Jeeves Cafe Table - Built To Order (BTO) Top Options

Jeeves Cafe Tables are 29" to 30" tall depending on the top thickness you choose. The Cafe height base is compatible with round or square BTO tops that are 24"x 24" to 48"x 48" (Wood or Laminate) OR 24"x 24" to 36"x 36" (Stone)

If you're looking for a top that is another shape, size or finish, please contact us.

We can make it happen! - hello@rypen.com / 800.560.0554

Solid wood tops are round or square in shape, 1" or 1.75" thick and are available with Square, Knife or Bullnose edge profiles. Solid wood tops are finished with commercial grade, matte clear lacquer unless otherwise specified. **INDOOR USE ONLY**



Laminate tops with plywood edges are round or square in shape, have a 1" thick, Baltic Birch ply core and are available with Square or Knife edge profiles. **INDOOR USE ONLY**

Laminate tops with matched or PVC edges are round or square in shape, have a 1" thick, MDF core and are available only in square edge profile. **INDOOR USE ONLY**



Stone tops are round or square in shape, 3cm (1.18") thick, and are available with Square or Bullnose edge profiles.

All stone tops are honed unless otherwise specified.

Our stone finishes are suitable for **INDOOR OR OUTDOOR USE!**

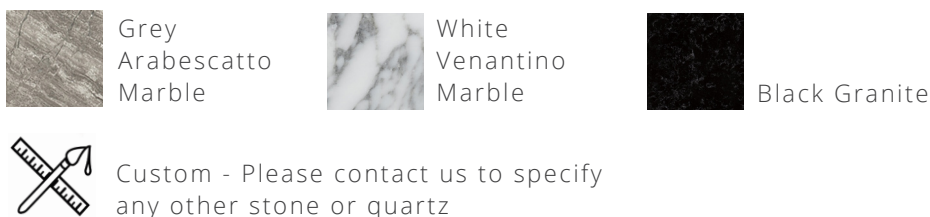

Jeeves Counter Table - Built To Order (BTO) Top Options

Jeeves Counter Tables are 36" to 37" tall depending on the top thickness you choose. The Counter height base is compatible with round or square BTO tops that are 24"x 24" to 36"x 36" (Wood or Laminate) OR 24"x 24" to 30"x 30" (Stone)

If you're looking for a top that is another shape, size or finish, please contact us.

We can make it happen! - hello@rypen.com / 800.560.0554

Solid wood tops are round or square in shape, 1" or 1.75" thick and are available with Square, Knife or Bullnose edge profiles. Solid wood tops are finished with commercial grade, matte clear lacquer unless otherwise specified. **INDOOR USE ONLY**



Laminate tops with plywood edges are round or square in shape, have a 1" thick, Baltic Birch ply core and are available with Square or Knife edge profiles. **INDOOR USE ONLY**

Laminate tops with matched or PVC edges are round or square in shape, have a 1" thick, MDF core and are available only in square edge profile. **INDOOR USE ONLY**



Stone tops are round or square in shape, 3cm (1.18") thick, and are available with Square or Bullnose edge profiles.

All stone tops are honed unless otherwise specified.

Our stone finishes are suitable for **INDOOR OR OUTDOOR USE!**

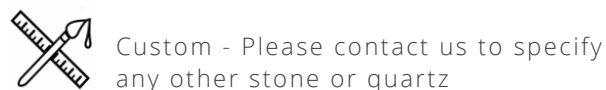

Jeeves Bar Table - Built To Order (BTO) Top Options

Jeeves Bar Tables are 42" to 43" tall depending on the top thickness you choose. The Bar height base is compatible with round or square BTO tops that are 24"x 24" to 30"x 30" (Wood or Laminate) OR 24"x 24" (Stone)

If you're looking for a top that is another shape, size or finish, please contact us.

We can make it happen! - hello@rypen.com / 800.560.0554

Solid wood tops are round or square in shape, 1" or 1.75" thick and are available with Square, Knife or Bullnose edge profiles. Solid wood tops are finished with commercial grade, matte clear lacquer unless otherwise specified. **INDOOR USE ONLY**



Laminate tops with plywood edges are round or square in shape, have a 1" thick, Baltic Birch ply core and are available with Square or Knife edge profiles. **INDOOR USE ONLY**

Laminate tops with matched or PVC edges are round or square in shape, have a 1" thick, MDF core and are available only in square edge profile. **INDOOR USE ONLY**



Stone tops are round or square in shape, 3cm (1.18") thick, and are available with Square or Bullnose edge profiles.

All stone tops are honed unless otherwise specified.

Our stone finishes are suitable for **INDOOR OR OUTDOOR USE!**

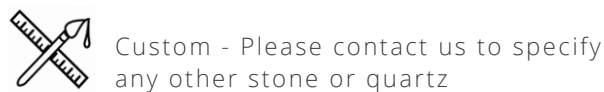

Jeeves Cafe Table - Built To Order (BTO) Base Options

The size and material of your Jeeves Cafe Table top will determine what baseplate you need to make a stable, functional table.

Our Jeeves posts and baseplates are suitable for indoor and outdoor use when paired with an appropriate top. They are heavy gauge steel with commercial grade powder coated finishes.

If the combination you're looking for doesn't seem to be lining up with our standardized options, please contact us. We'll help sort it out! - hello@rypen.com / 800.560.0554



Cafe Height Post

Available for quick-ship in Matte White or Matte Black powder coats. Custom powder coating is available with an extended lead time, please contact us if you're looking for another color.

The compatibilities listed below are for the baseplates when paired with a Cafe Height Post:

Small Baseplate (17.5" diameter)

For wood/laminate tops 24" to 30" and 24" stone tops

Medium Baseplate (21" diameter)

For wood/laminate tops 31" to 36" and stone tops 25" to 30"

Large Baseplate (25.5" diameter)

For wood/laminate tops 37" to 48" and stone tops 31" to 36"

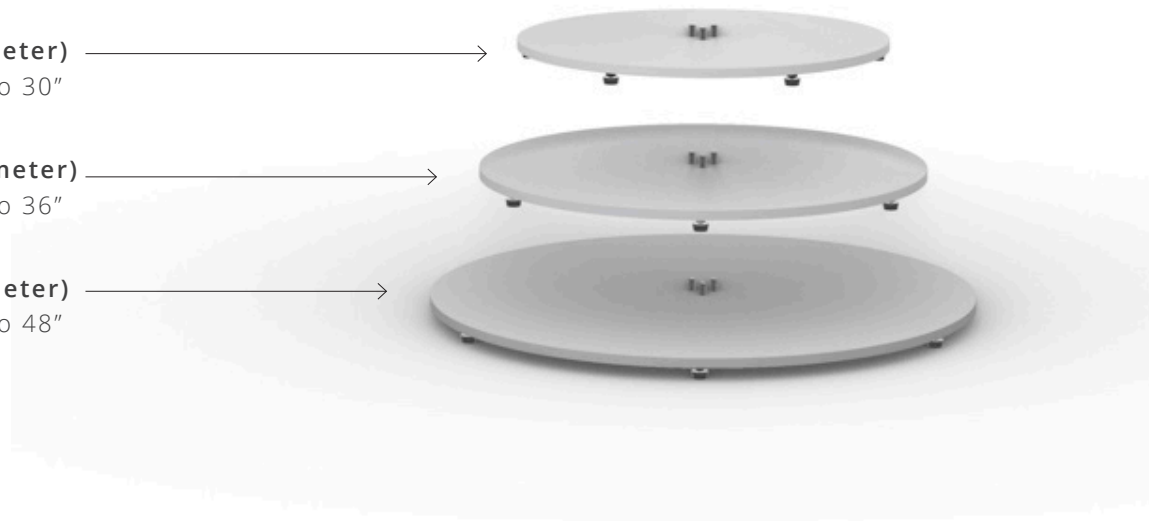

Quick Ship Bases:

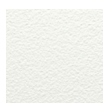

MATTE WHITE
Powder coated steel
Indoor/Outdoor Safe



MATTE BLACK
Powder coated steel
Indoor/Outdoor Safe

Custom Powder Coats



Please contact us for RAL color-matching or any other custom finish questions.

Jeeves Counter Table - Built To Order (BTO) Base Options

The size and material of your Jeeves Counter Table top will determine what baseplate you need to make a stable, functional table.

Our Jeeves posts and baseplates are suitable for indoor and outdoor use when paired with an appropriate top. They are heavy gauge steel with commercial grade powder coated finishes.

If the combination you're looking for doesn't seem to be lining up with our standardized options, please contact us. We'll help sort it out! - hello@rypen.com / 800.560.0554

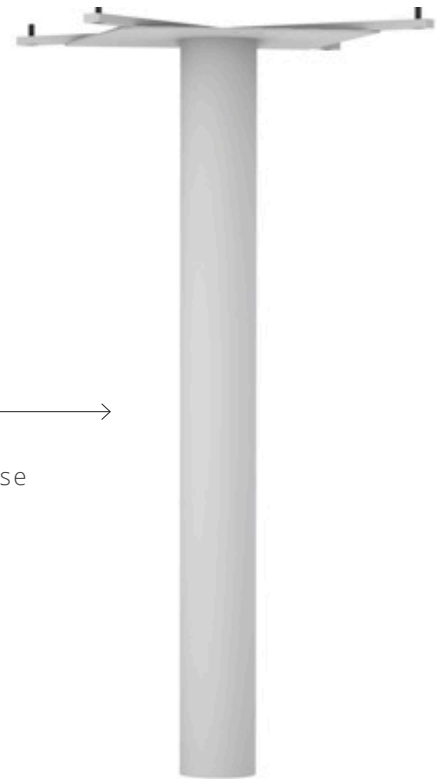

Counter Height Post →

Available for quick-ship in Matte White or Matte Black powder coats. Custom powder coating is available with an extended lead time, please contact us if you're looking for another color.

The compatibilities listed below are for the baseplates when paired with a Counter Height Post:

Medium Baseplate (21" diameter) →

For wood/laminate tops 24" to 30" and 24" stone tops

Large Baseplate (25.5" diameter) →

For wood/laminate tops 31" to 36" and stone tops 25" to 30"

Note: Small Baseplate is not recommended for counter height tables.

Quick Ship Bases:

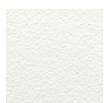

MATTE WHITE
Powder coated steel
Indoor/Outdoor Safe



MATTE BLACK
Powder coated steel
Indoor/Outdoor Safe

Custom Powder Coats



Please contact us for RAL color-matching or any other custom finish questions.

Jeeves Bar Table - Built To Order (BTO) Base Options

The size and material of your Jeeves Bar Table top will determine what baseplate you need to make a stable, functional table.

Our Jeeves posts and baseplates are suitable for indoor and outdoor use when paired with an appropriate top. They are heavy gauge steel with commercial grade powder coated finishes.

If the combination you're looking for doesn't seem to be lining up with our standardized options, please contact us. We'll help sort it out! - hello@rypen.com / 800.560.0554

Bar Height Post

Available for quick-ship in Matte White or Matte Black powder coats. Custom powder coating is available with an extended lead time, please contact us if you're looking for another color.

The compatibilities listed below are for the baseplates when paired with a Bar Height Post:

Medium Baseplate (21" diameter)

For 24" wood/laminate and stone tops

Large Baseplate (25.5" diameter)

For wood/laminate and stone tops
25" to 30"

Note: Small Baseplate is not recommended for bar height tables.

Quick Ship Bases:

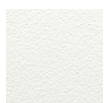

MATTE WHITE
Powder coated steel
Indoor/Outdoor Safe



MATTE BLACK
Powder coated steel
Indoor/Outdoor Safe

Custom Powder Coats



Please contact us for RAL color-matching or any other custom finish questions.